

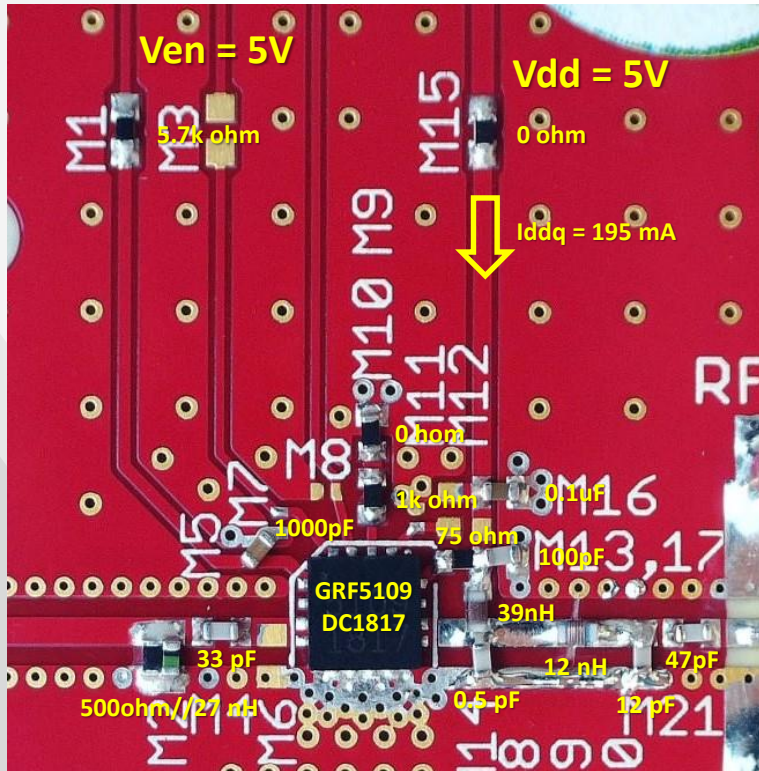

GRF5109 (200 - 400 MHz)

GRF5109 Schematic:



GRF5109 Response:

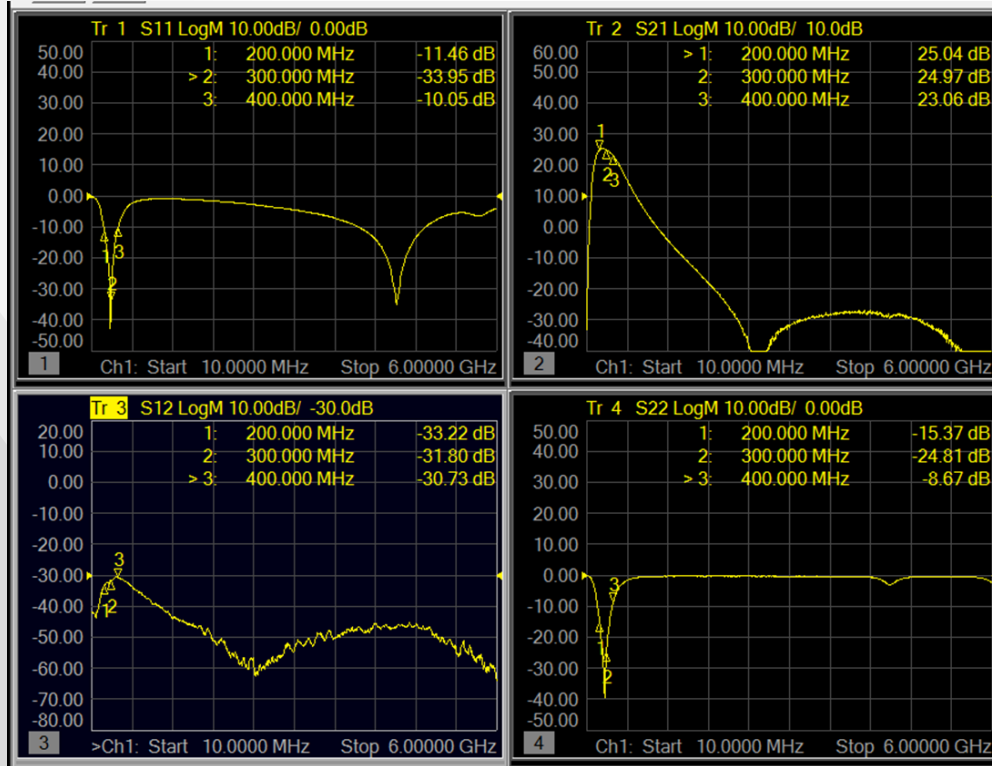

GRF5109 Stability Mu Factor:

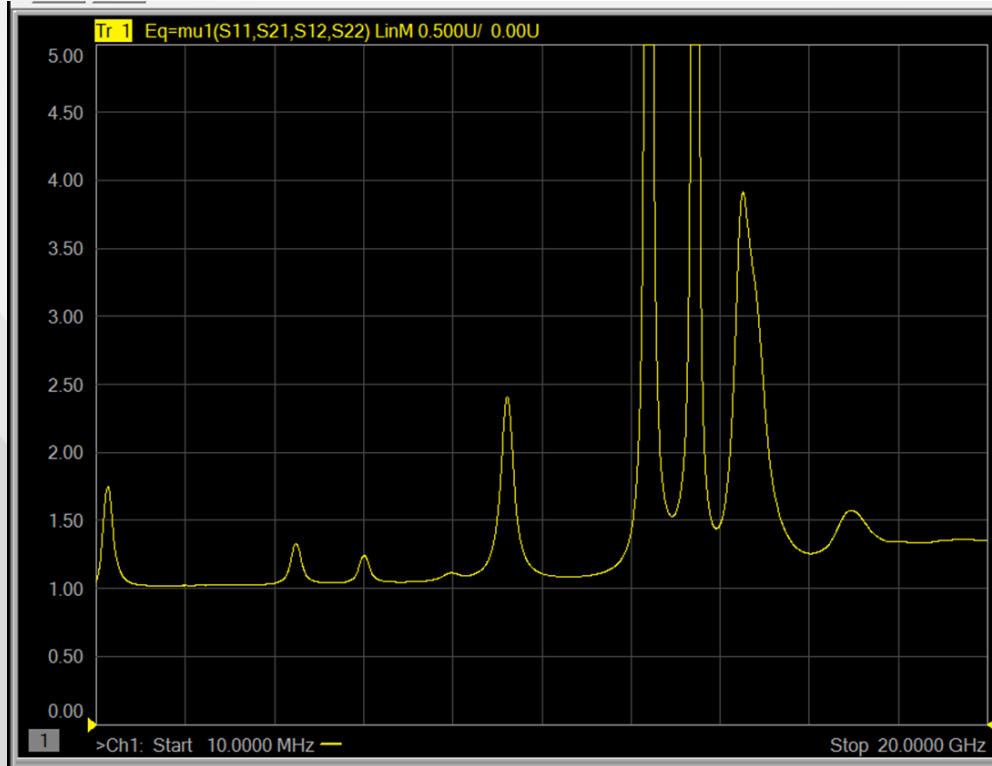

GRF5109 Data: NF

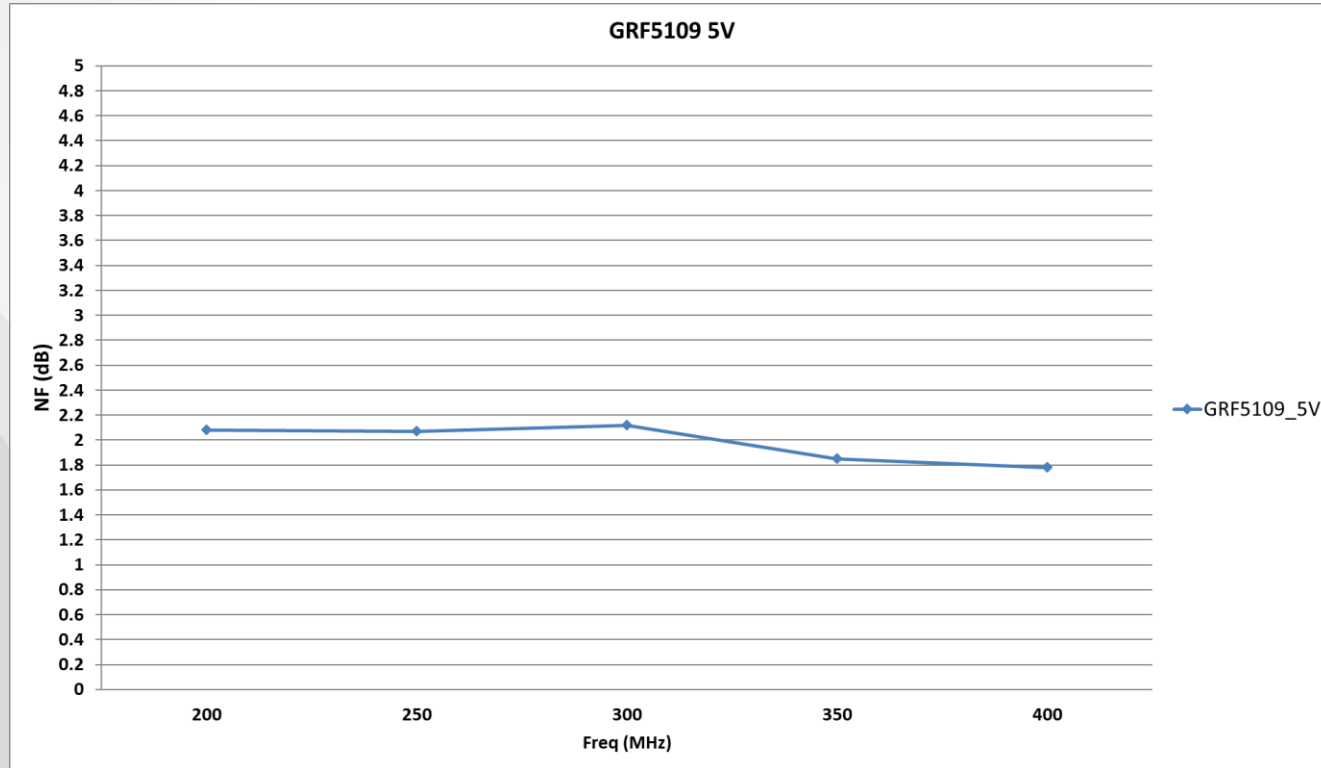

GRF5109 Data: Gain

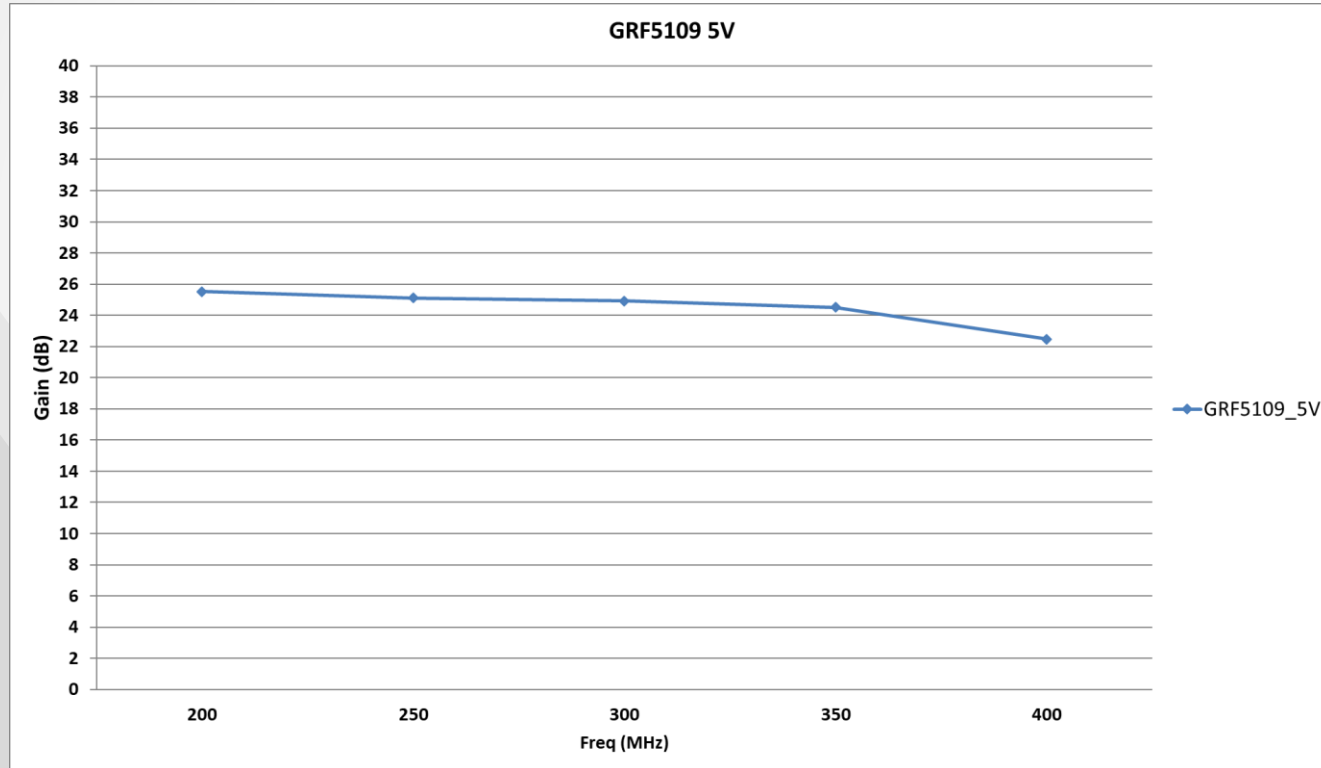

GRF5109 Data: IIP3

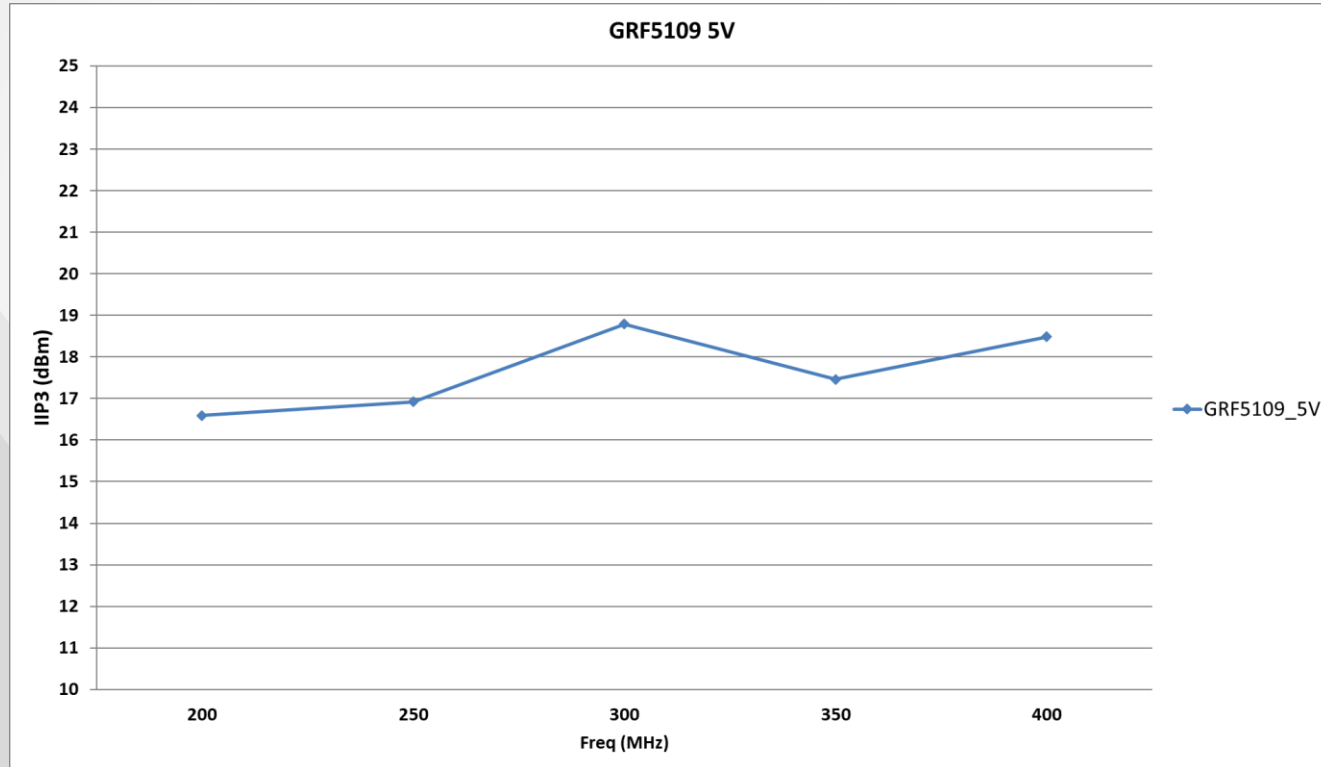

GRF5109 Data: OIP3

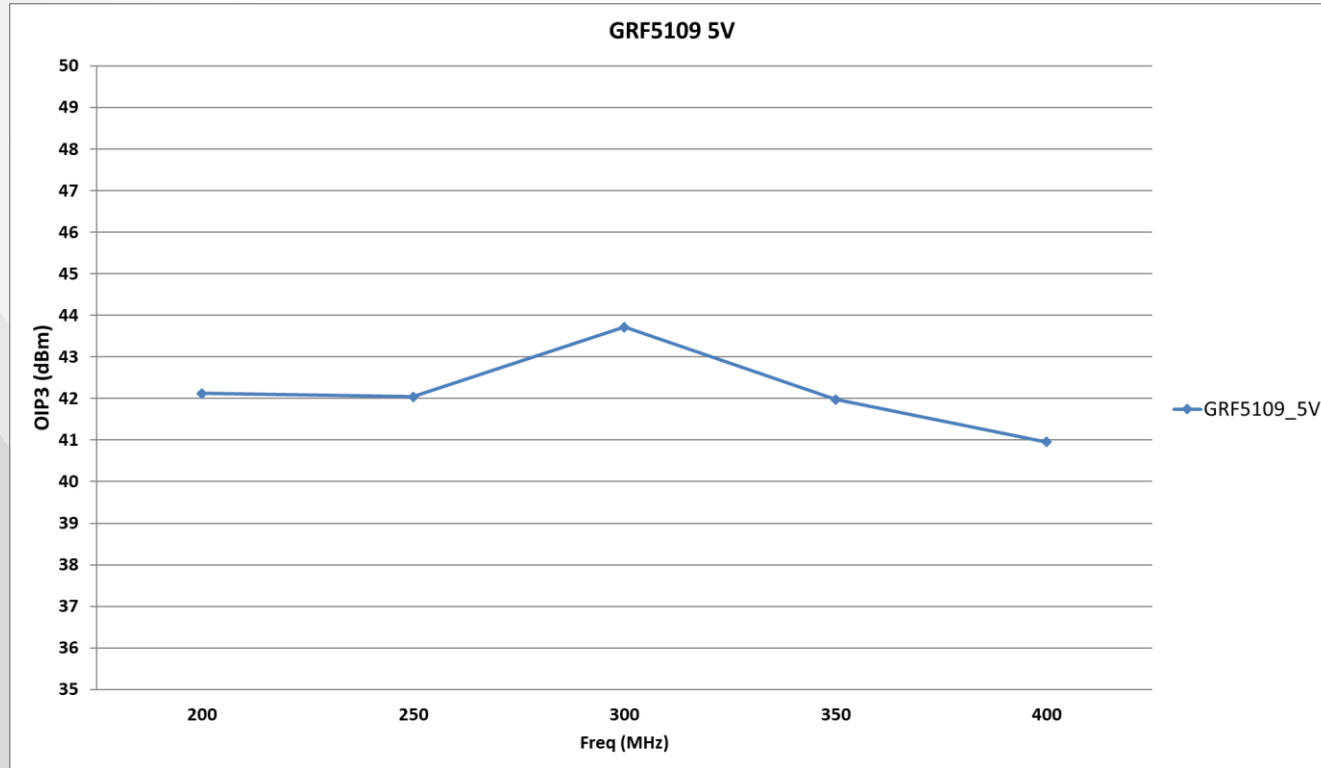

GRF5109 Data: IP1dB

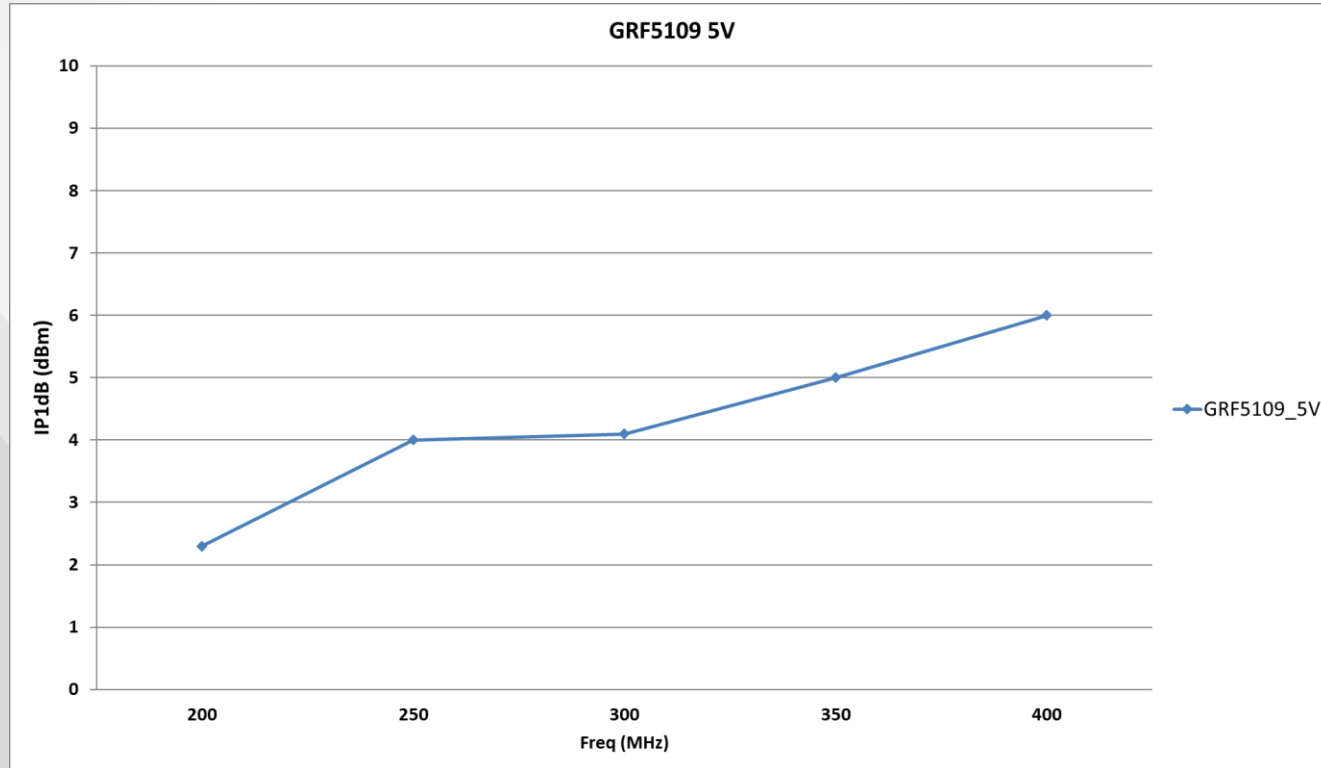

GRF5109 Data: OP1dB

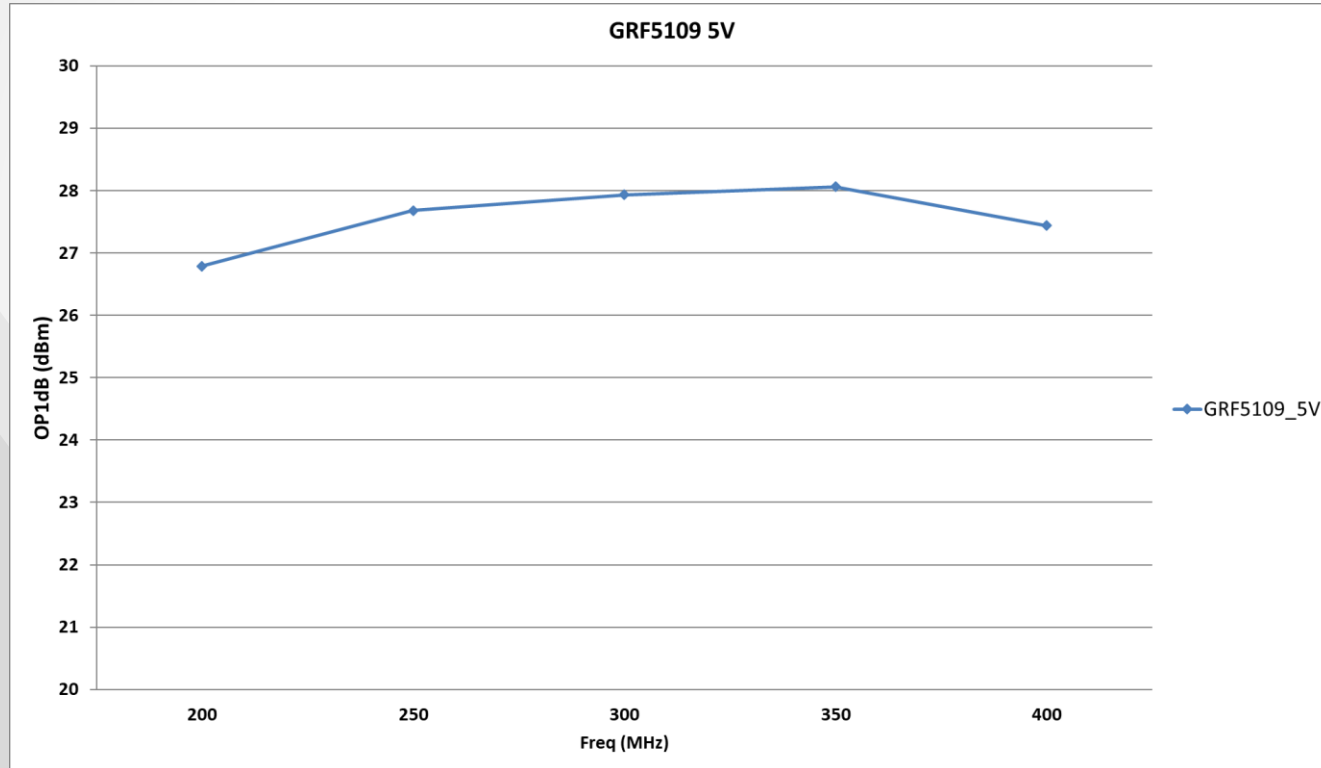



Jeff Broxson

Vice President - Sales

Phone (336) 339-9314

jbroxson@guerrilla-rf.com

Alan Ake

Vice President - Applications/Technical Marketing

Phone (336) 708-4581

aake@guerrilla-rf.com

Guerrilla RF

1196 Pleasant Ridge Road, Suite 5
Greensboro, NC 27409

Phone: (336) 510-7840

www.guerrilla-rf.com