

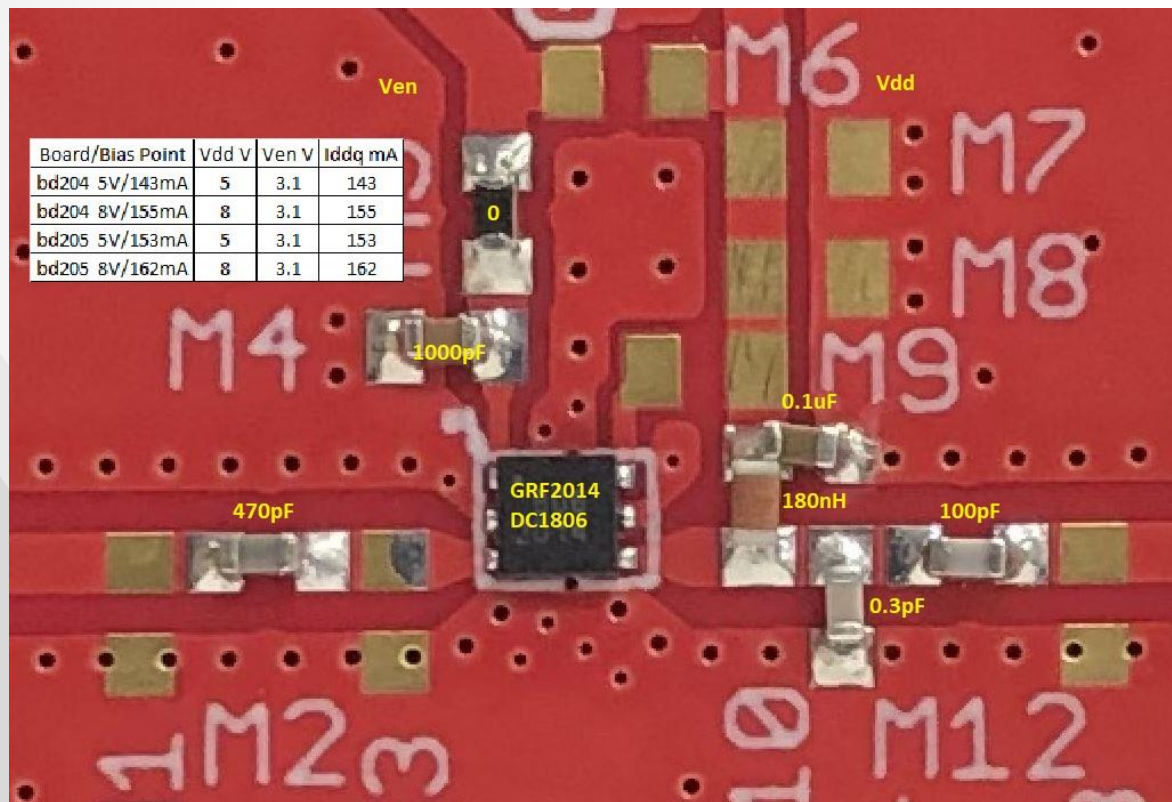

GRF2014 (100 - 1800 MHz)

GRF2014 Schematic:



GRF2014 Response:

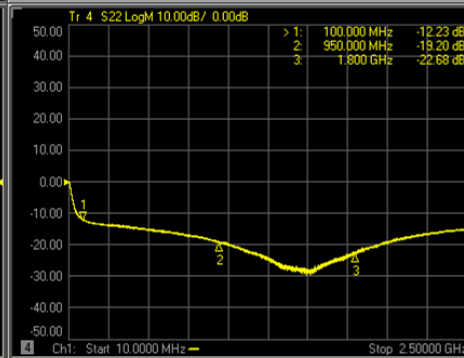
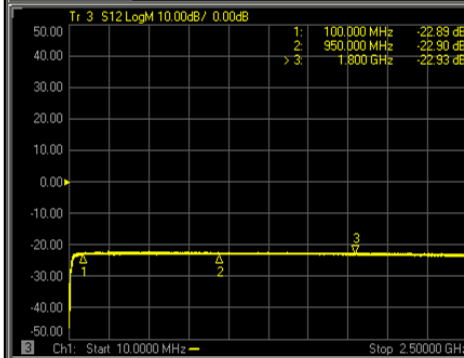
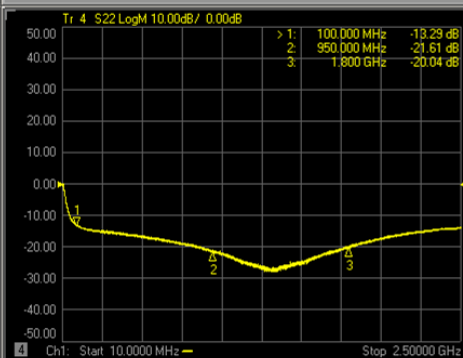
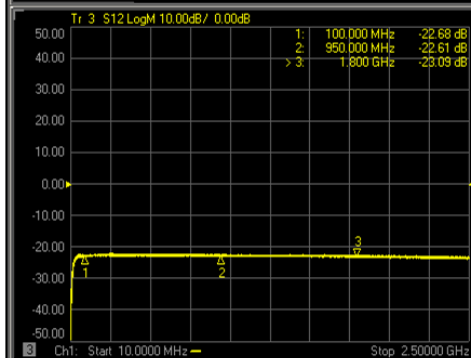
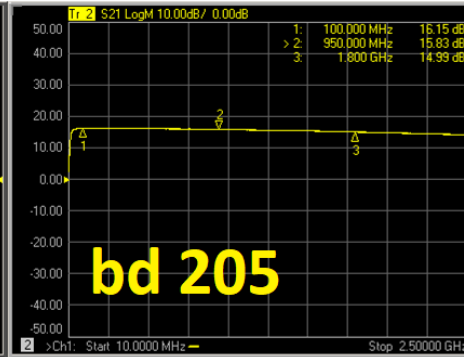
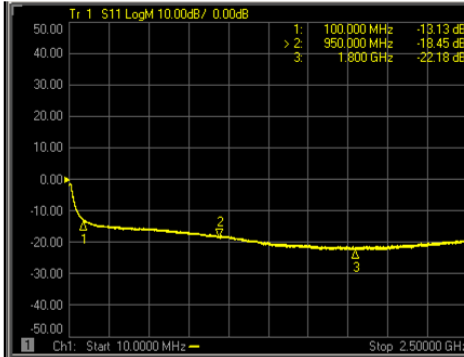
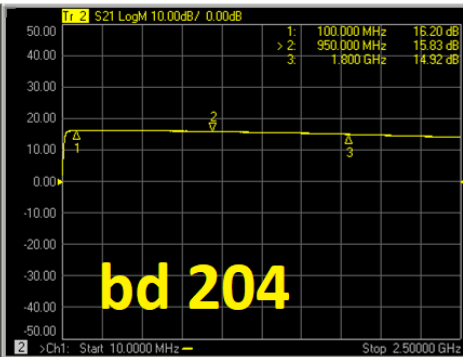
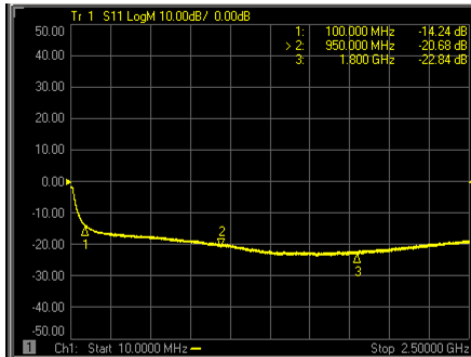

GRF2014 Stability Mu Factor:



GRF2014 Noise Figure:

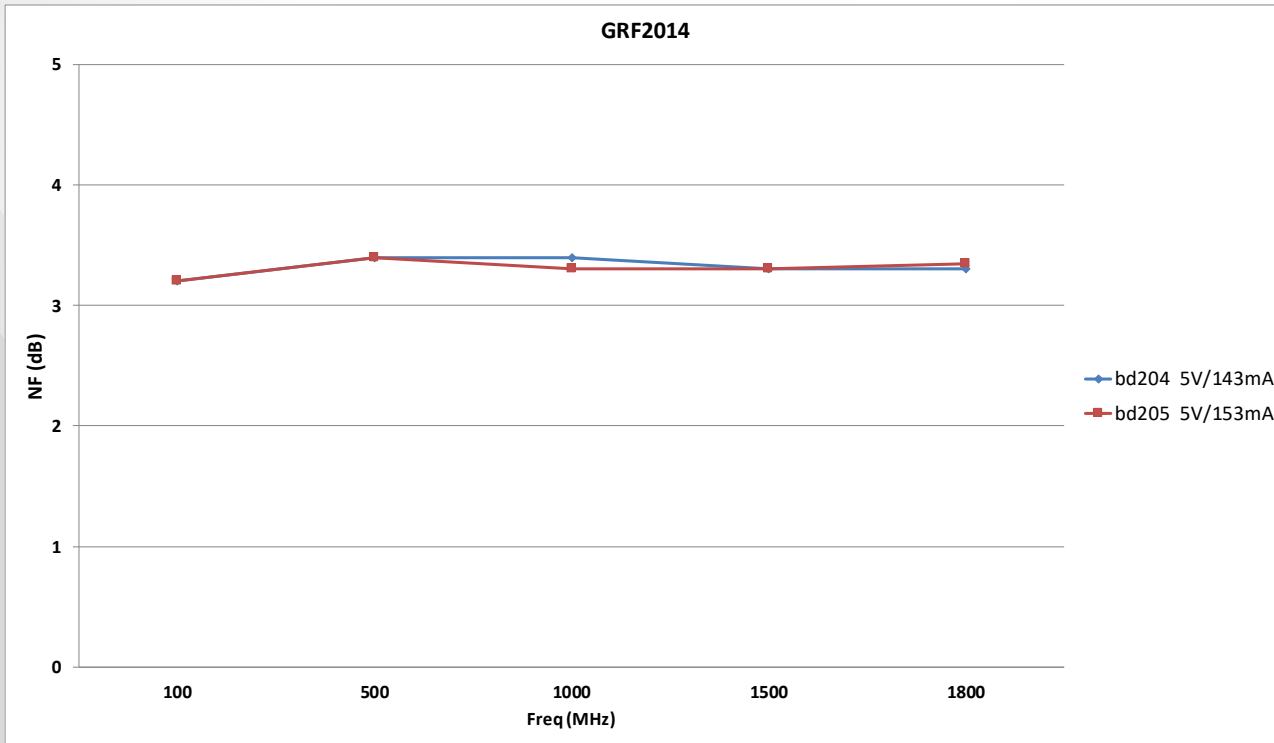

GRF2014 Gain:

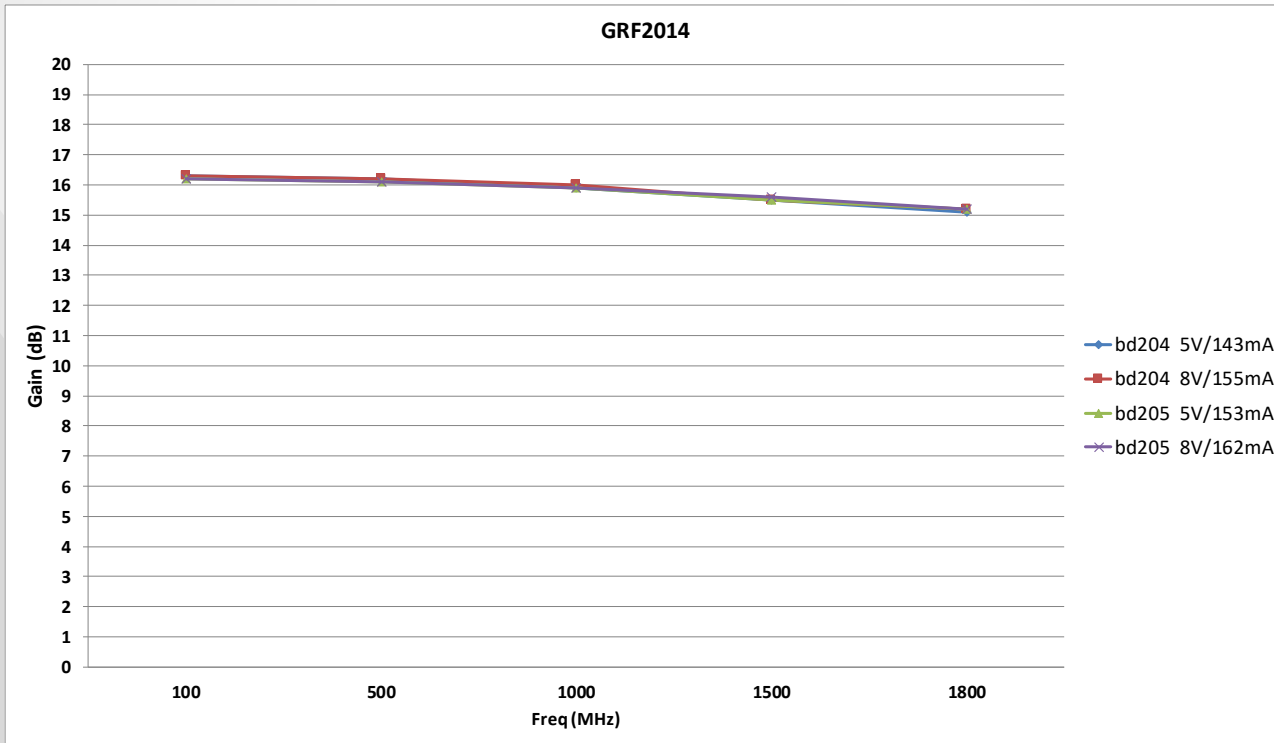

GRF2014 IIP3:

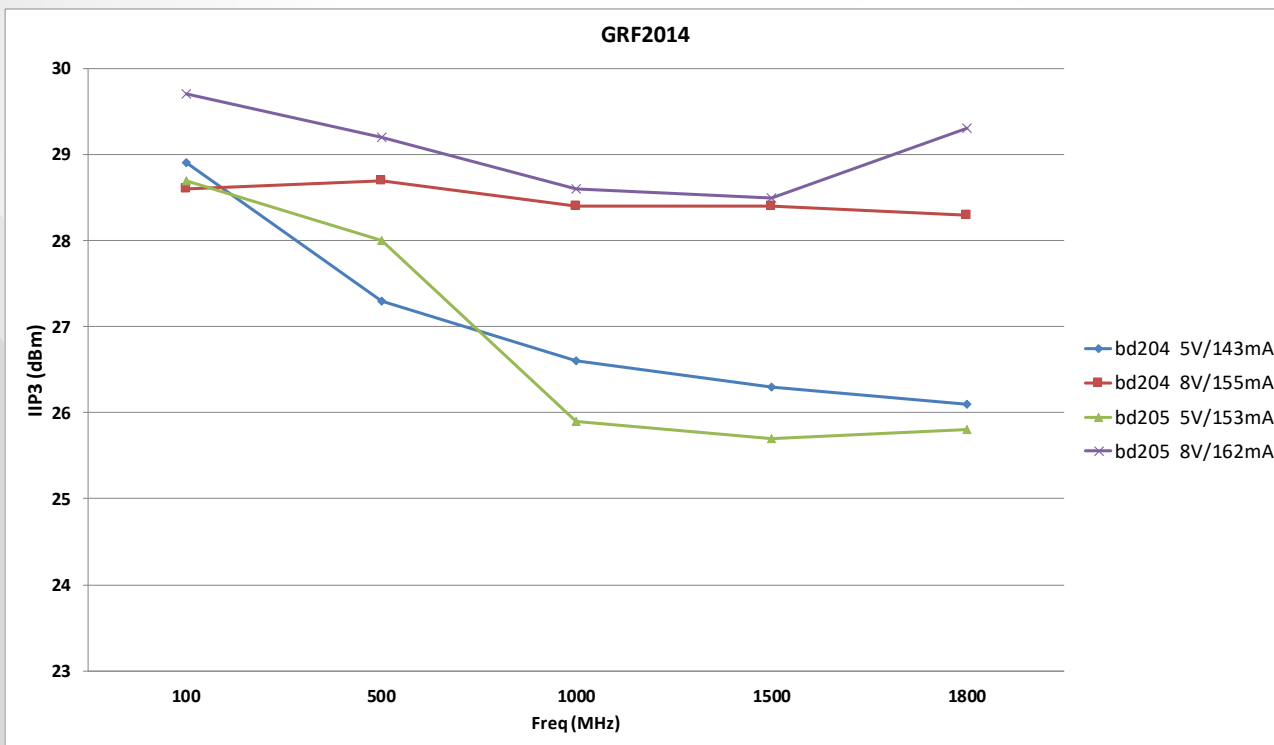

GRF2014 OIP3:

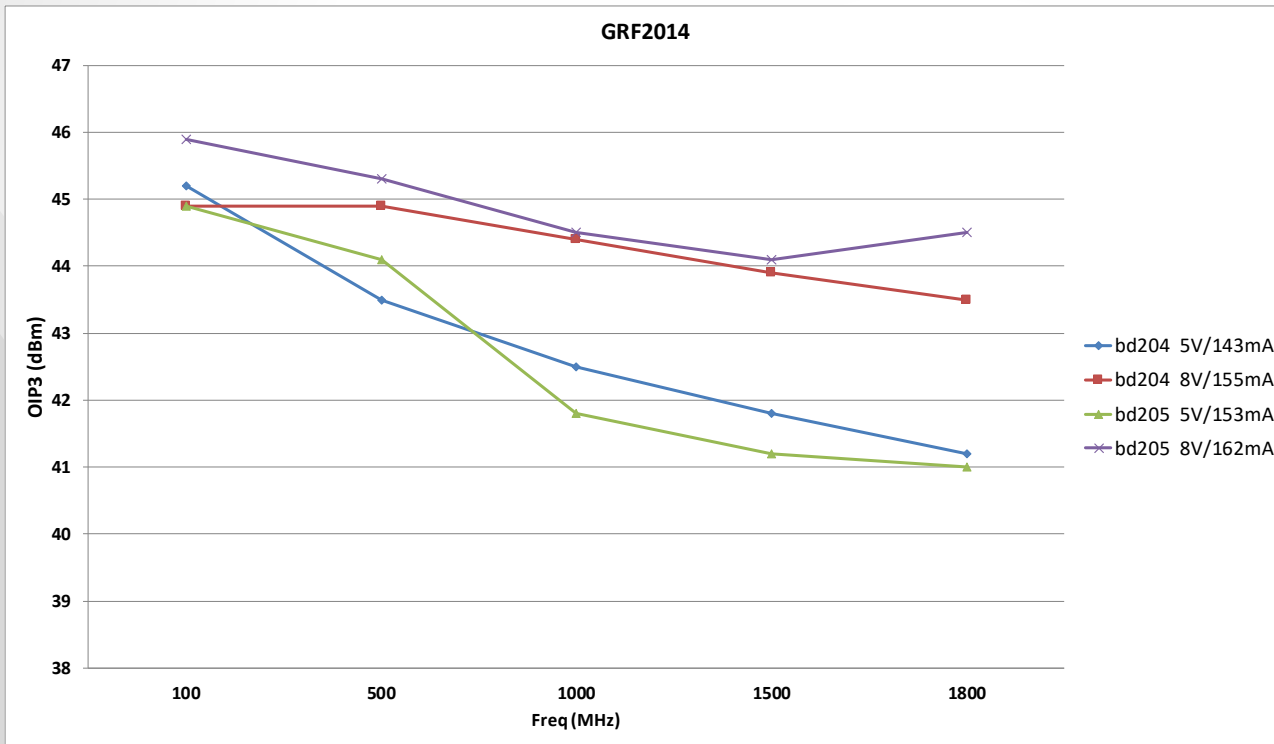

GRF2014 IP1dB:

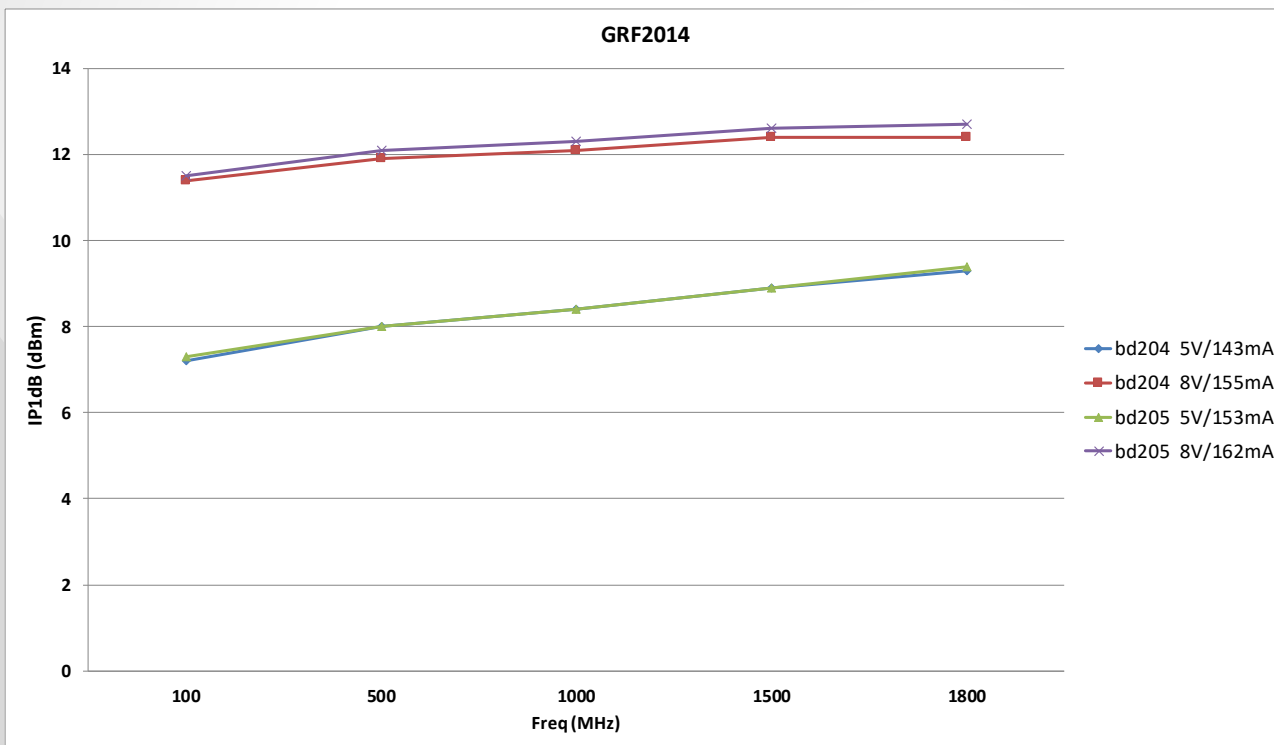

GRF2014 OP1dB:

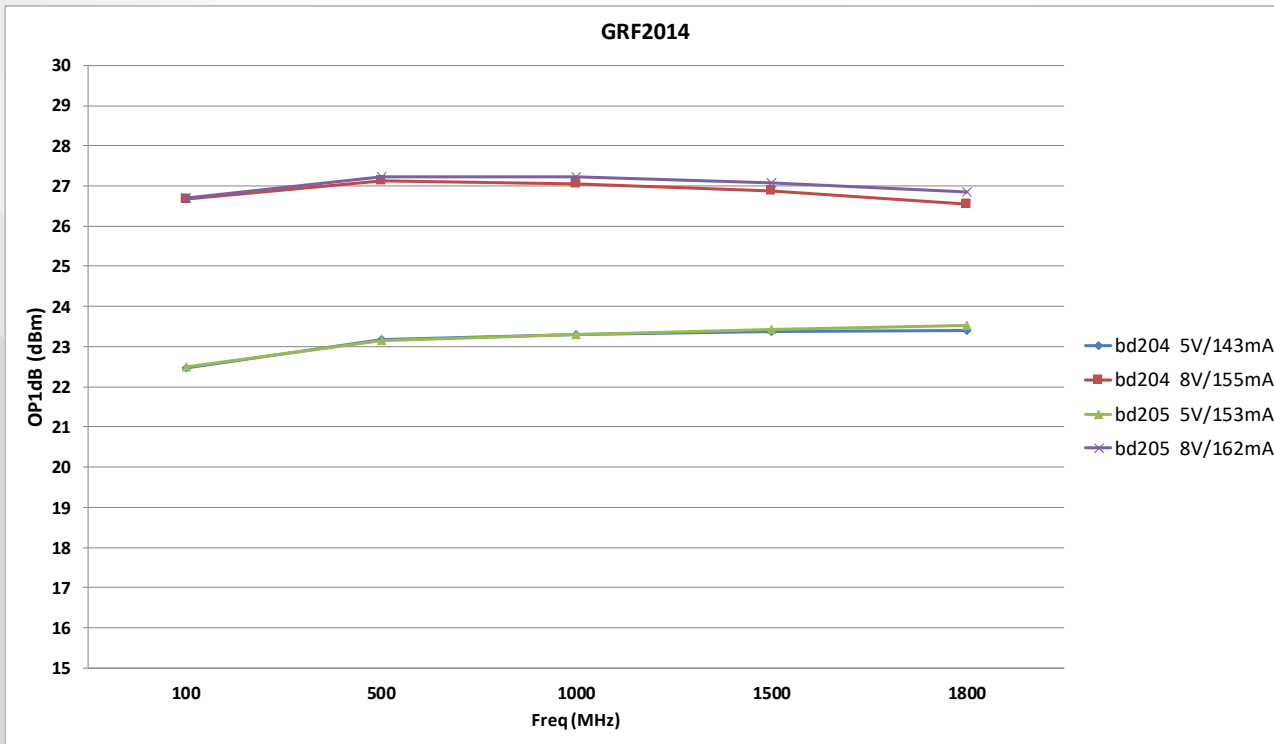

GRF2014 2nd Harmonic:

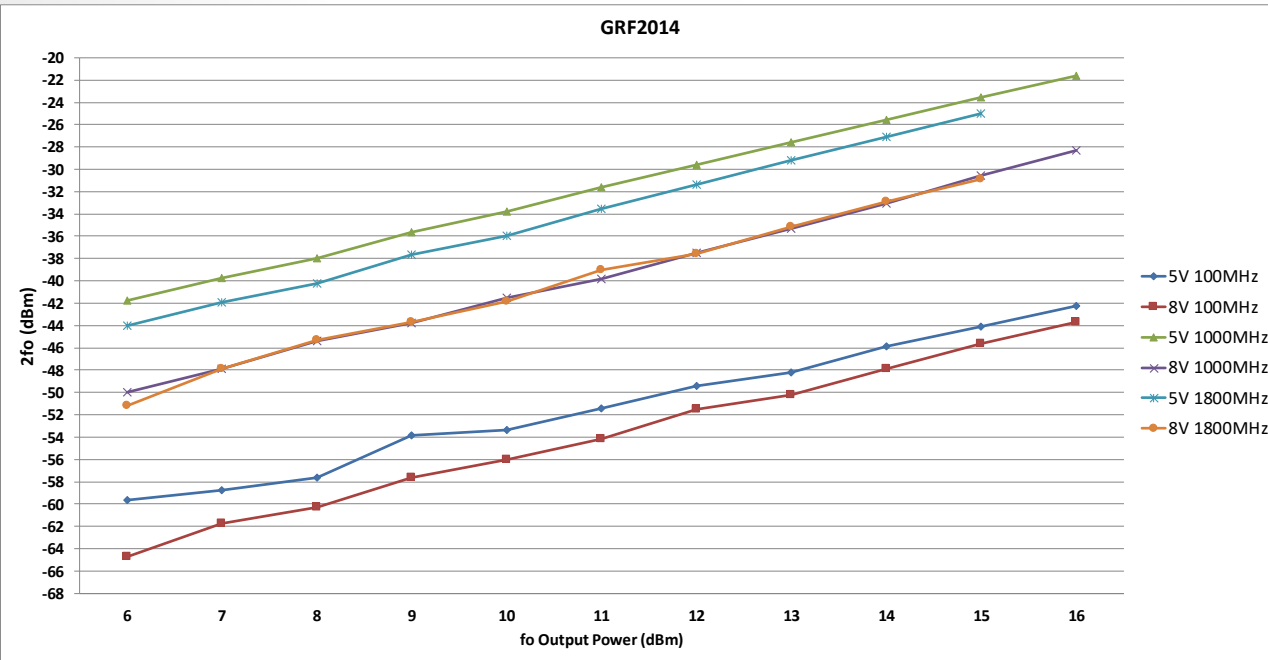

GRF2014 OIP2:

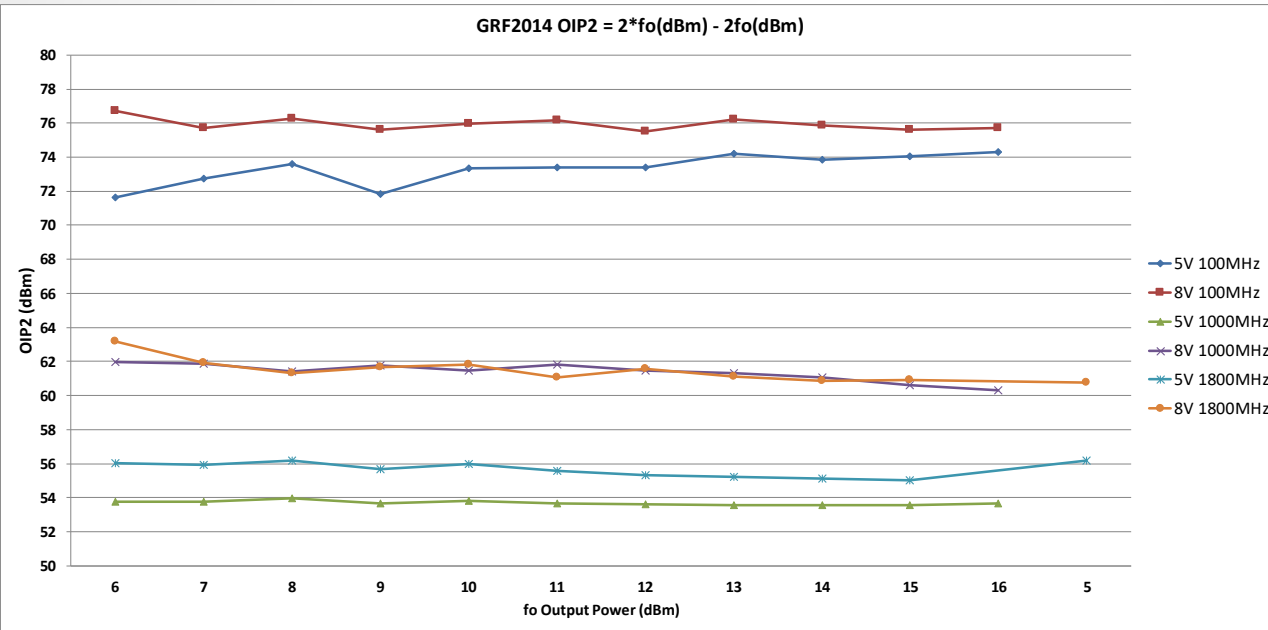



Jeff Broxson

Vice President - Sales

Phone (336) 339-9314

jbroxson@guerrilla-rf.com

Alan Ake

Vice President - Applications/Technical Marketing

Phone (336) 708-4581

aake@guerrilla-rf.com

Guerrilla RF

1196 Pleasant Ridge Road, Suite 5
Greensboro, NC 27409

Phone: (336) 510-7840

www.guerrilla-rf.com